

# Index

---

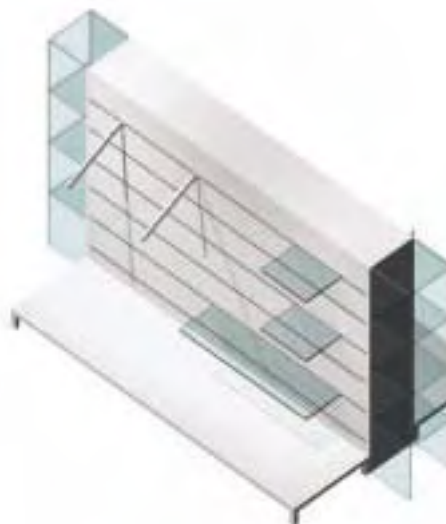

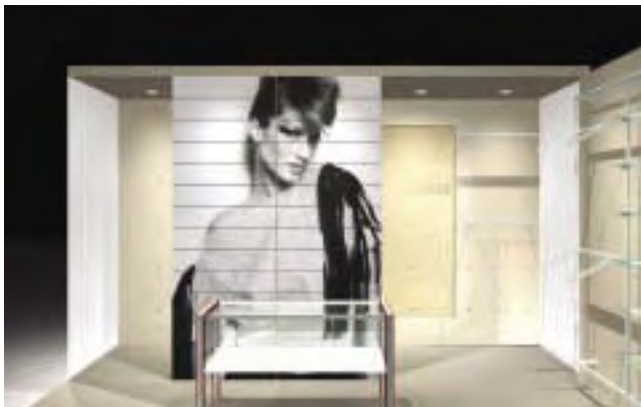







<b>Applications</b>	<b>2</b>
<b>Material Symbols</b>	<b>4</b>
<b>How to read the catalogue</b>	<b>5</b>
<b>Assembly instructions and weight capacity</b>	<b>6</b>
<b>Program overview</b>	<b>7</b>
<b>Slatwall® Thinline Panels</b>	<b>8</b>
<b>Slatwall® Thinline Panels - digital image prints</b>	<b>10</b>
<b>Structures</b>	<b>12</b>
<b>Metal Accessories</b>	<b>14</b>
<b>Acrylic Accessories</b>	<b>22</b>





# Material Symbols

---

-  **Laminated MDF Panel**
-  **Painted MDF Panel**
-  **Chromed Metal**
-  **Raw material**
-  **Glass**
-  **Anodised aluminium**
-  **Acrylic**
-  **Clear acrylic**
-  **Panels with special finishing**
-  **Powdercoated paint finish**



# Assembly instructions and weight capacity

## 1 Wall spacers assembly

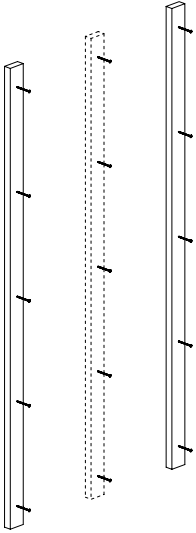

Fix two wall spacers to wall

## 2 Panel positioning

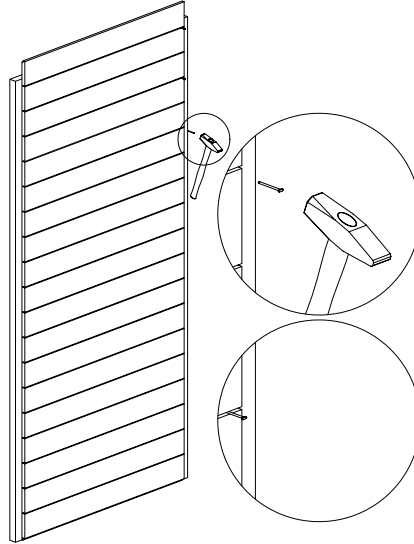

Tack nails to temporarily fix the panel, positioning the nails at every second groove.

## 3 Panel fixing

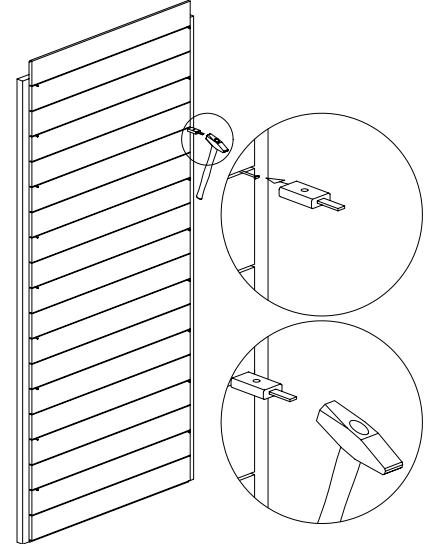

Fix the insert tool onto nail-head and turn it so that its tongue goes into the groove. Then complete fixing the nail securely.

## 4 Aligning panels

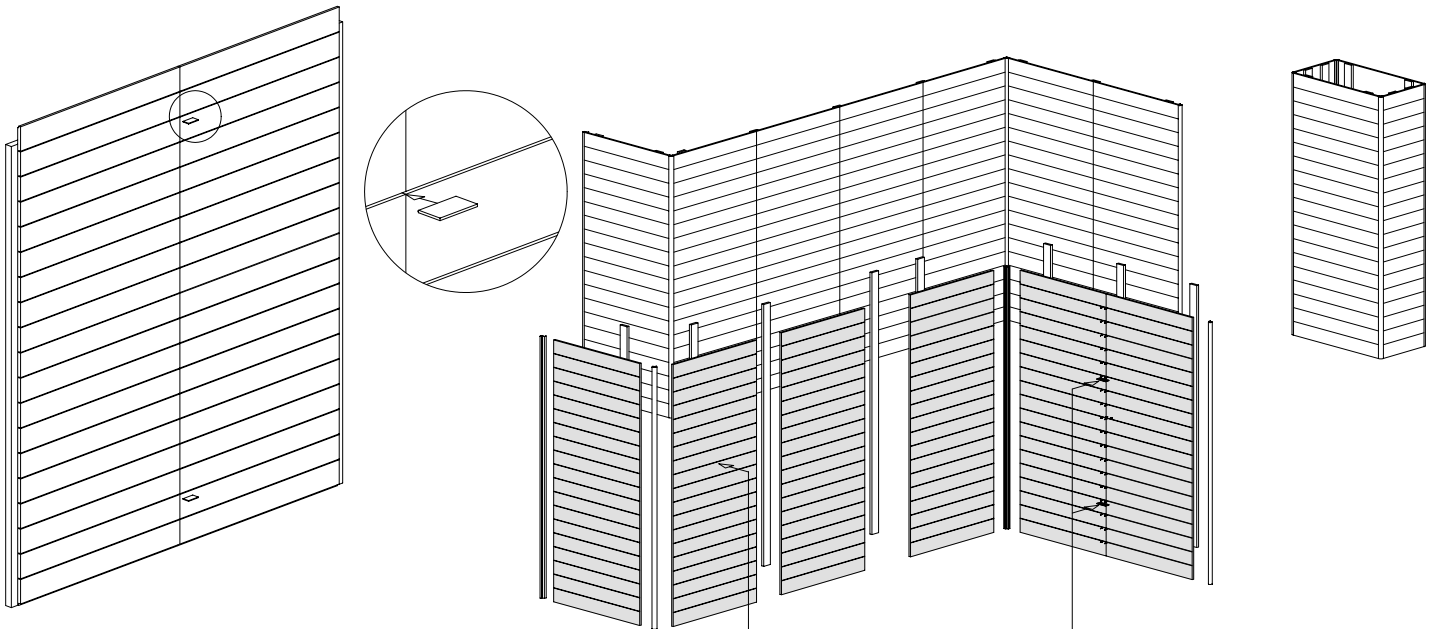

Use alignment tool to correctly align panels. Remove alignment tool after fixing panels.

Slatwall®Thinline Panels

Alignment inserts to be fitted during assembly

## Weight Capacity

- Maximum weight capacity:
- a) for panel secured using two spacers = 180kgs (distributed evenly)
  - b) for panel secured using three spacers = 230kgs (distributed evenly)

# Program Overview

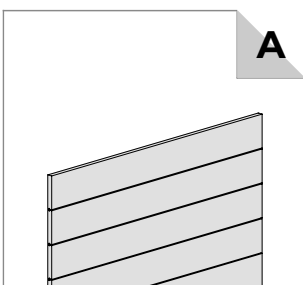
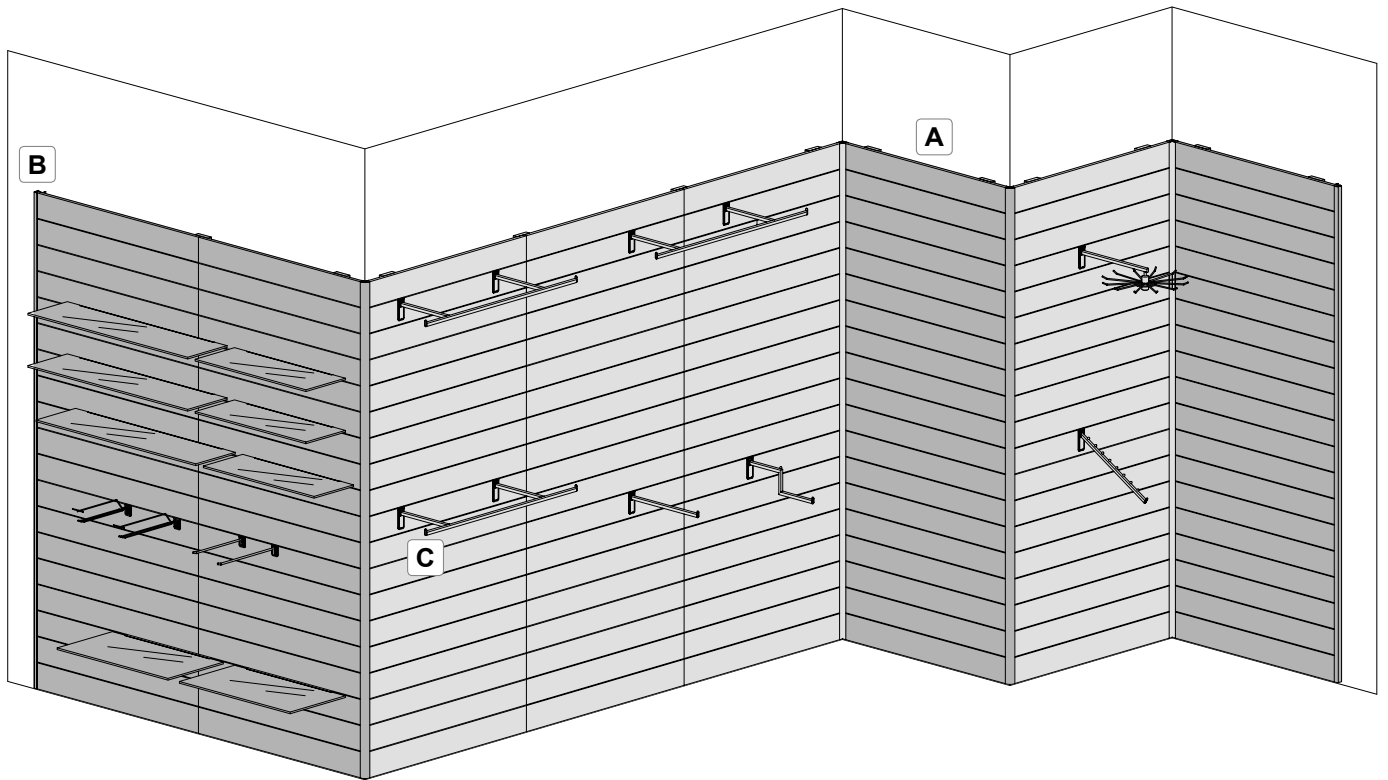

**Slatwall®Thinline Panels**

Page 8

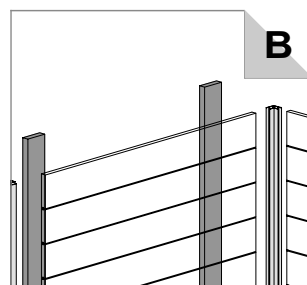

**Structures**

Page 12

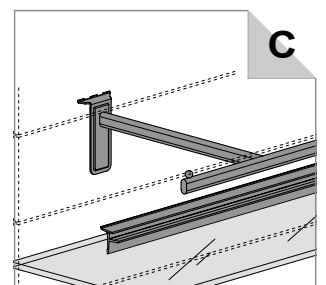

**Accessories**

Page 14

# Slatwall®Thinline Panels

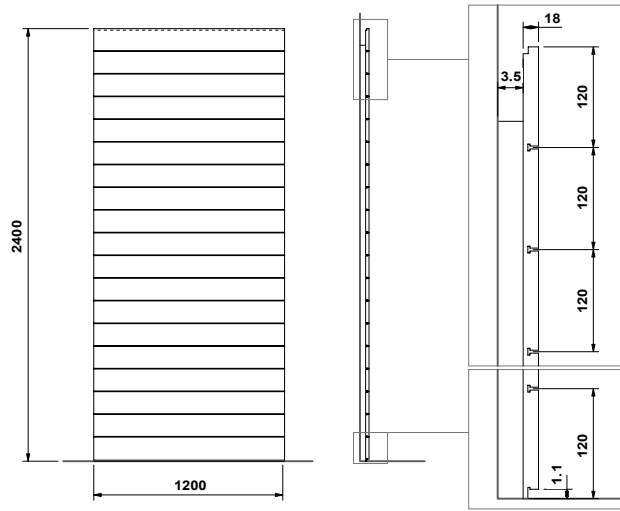
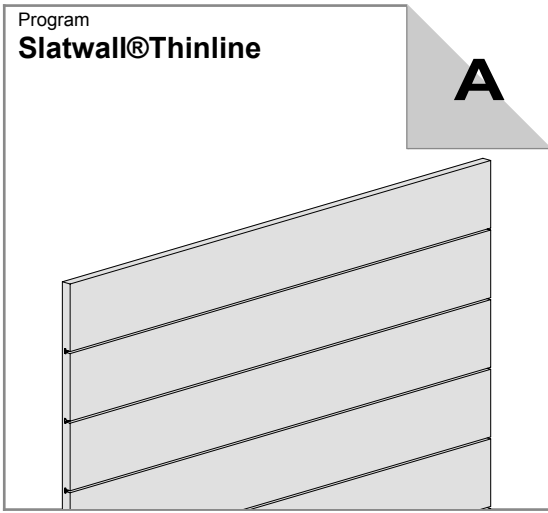



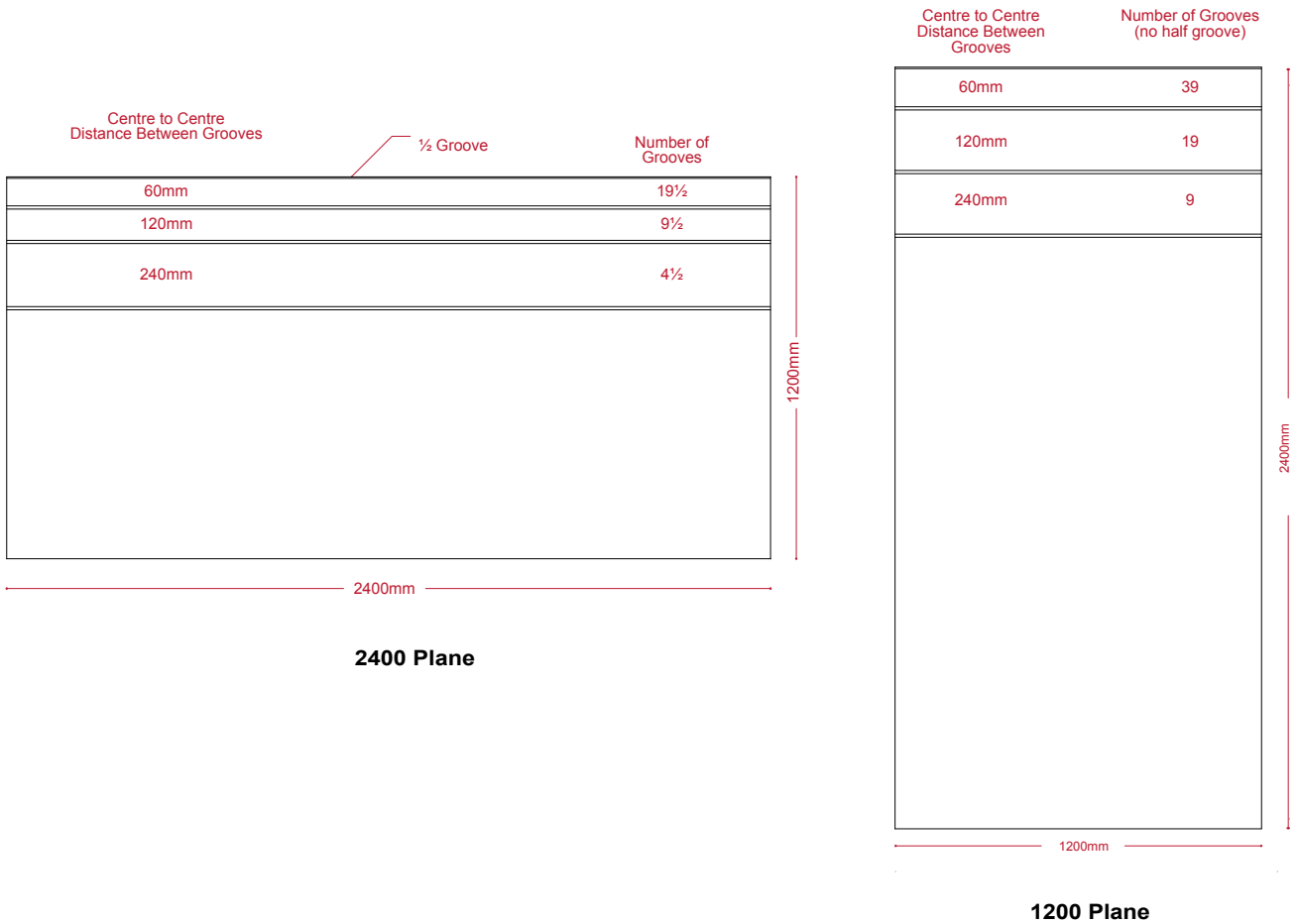

## Standard groove configuration

Slatwall®Thinline can be routed on either the 1200 or 2400 plane, in any configuration. Stock held panels are available in 19½, 9½, and 4½ grooves on the 2400 plane. Groove configurations are easily varied to meet display requirements across either plane.

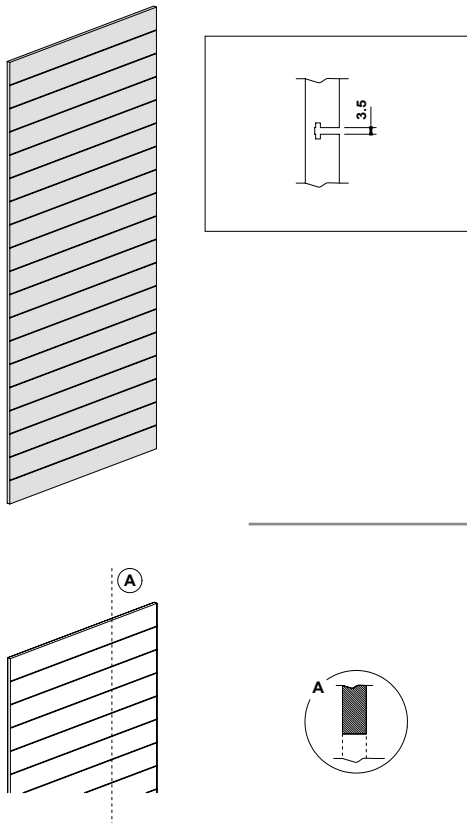
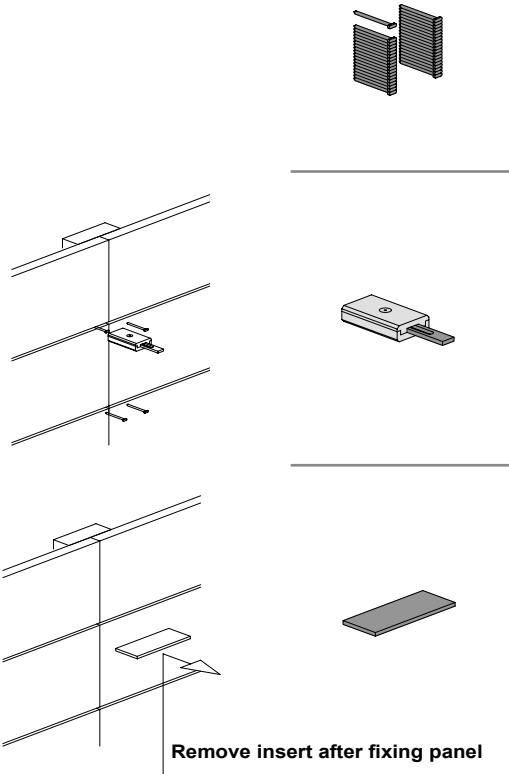

# Slatwall®Thinline Panels

Program <b>Slatwall®Thinline</b>	Details	<b>P</b>	<b>H</b>	<b>L</b>	Code	<b>c1</b>	<b>c2</b>	<b>c3</b>	<b>c4</b>	<b>c5</b>	<b>c6</b>
<b>Slatwall®Thinline Panel - Groove Configurations</b> (price may vary depending on board finish selected)	<b>2400 Plane</b> 60mm ctc - 19½ grooves 120mm ctc - 9½ grooves 240mm ctc - 4½ grooves  Custom groove configuration  <b>1200 Plane</b> 60mm ctc - 39 grooves 120mm ctc - 19 grooves 240mm ctc - 9 grooves  Custom groove configuration	18 18 18  18 18 18  18	1200 1200 1200  1200 1200 1200  1200	2400 2400 2400  2400 1200 1200  1200	<b>1B25 001</b> <b>1B25 002</b> <b>1B25 003</b>  <b>1B25 005</b>  <b>1B25 006</b> <b>1B25 007</b> <b>1B25 008</b>  <b>1B25 010</b>						
	<b>Panel cut to size</b> (panel size to be specified)				<b>91B98 020</b>						
<b>Panel fixing components</b>  <p>Remove insert after fixing panel</p>	<b>Nail Kit (200 nails)</b>		32		<b>1B98 001</b>						
<b>Insert tool for nails</b>	60			<b>1B98 002</b>							
<b>Alignment insert</b>	35			<b>1B98 003</b>							

## Slatwall®Thinline Panels - digital image prints

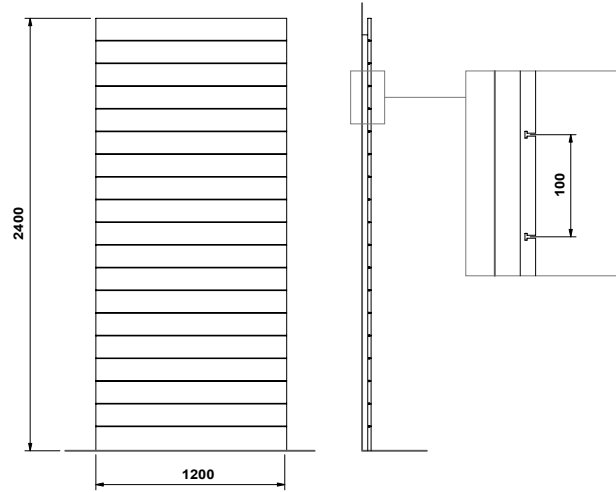
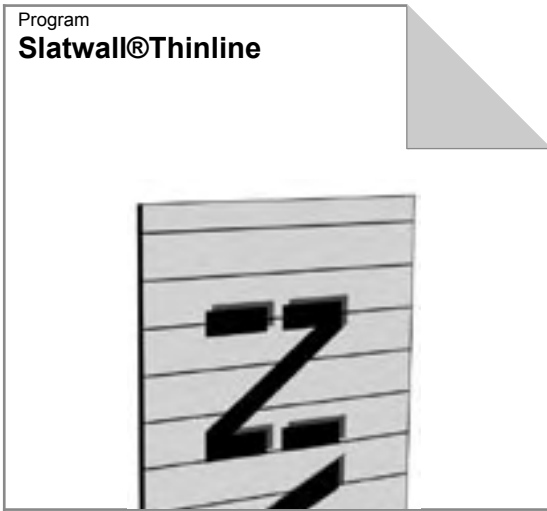

Digital image application is ideal on Slatwall®Thinline panels. Customers should supply artwork to their ASI Consultant on CD. Image provided should be at least 200dpi at actual size.

# Slatwall®Thinline Panels - digital image prints

Program  
**Slatwall®Thinline**

Details

P

H

L

Code

c1

c2

c3

c4

c5

c6

Digital image print for Slatwall®Thinline panels



From 0 to 20 metres square

1B26 001



From 20 to 100 metres square

1B26 002



100+ metres square

1B26 003



Price is per square meter.

Price is for digital image printing including application, and protection film.

Price does not include panel.

# Structures

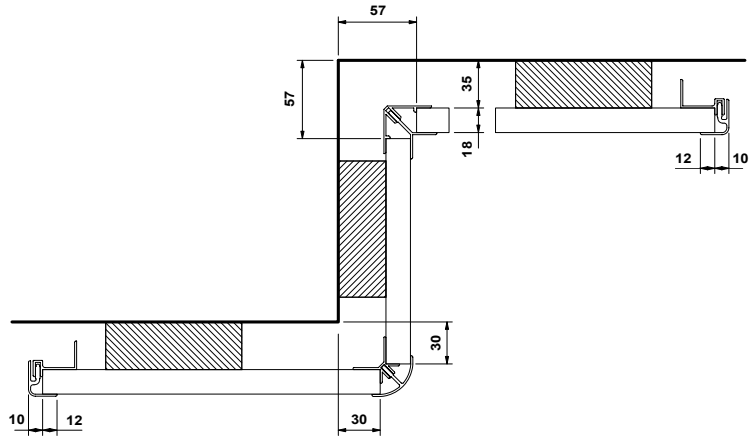
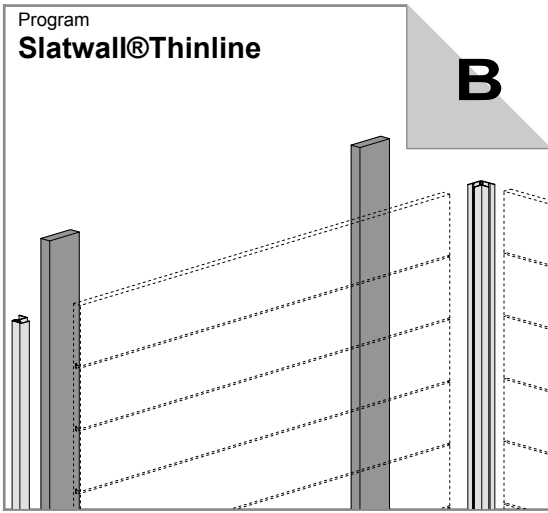

## Assembly guide

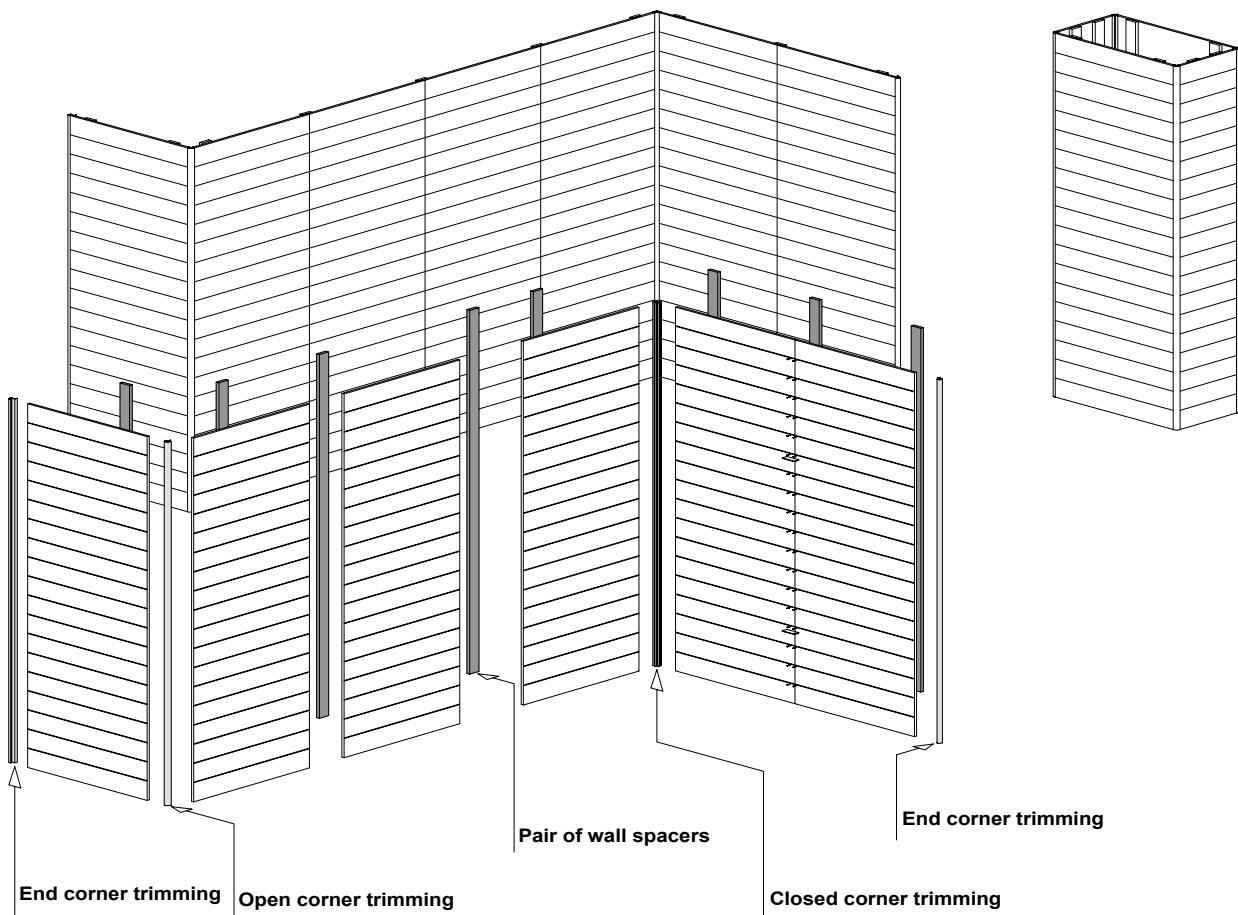

# Structures

Program  
**Slatwall@Thinline**

Details

P

H

L

Code

c1

c2

c3

c4

c5

c6

## End and corner trimmings

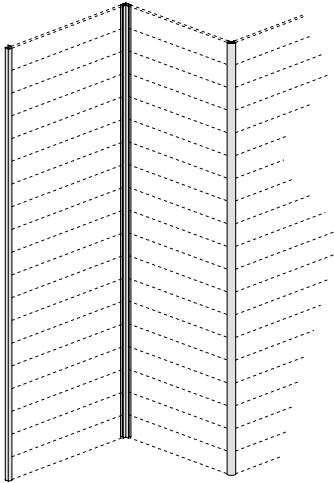

### End corner trimming

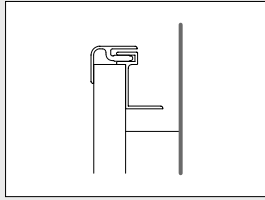

2400

**1B27 005**



### Closed corner trimming

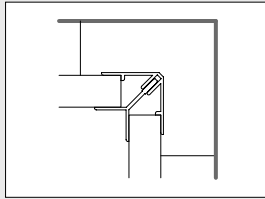

2400

**1B27 006**



### Open corner trimming

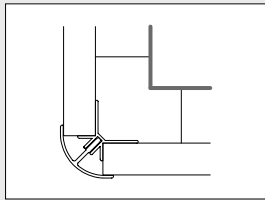

2400

**1B27 007**



# Metal Accessories

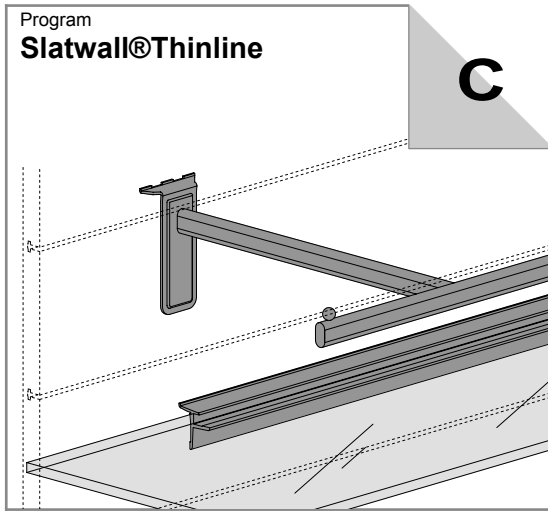

## Glass shelf holder and 8mm glass shelving

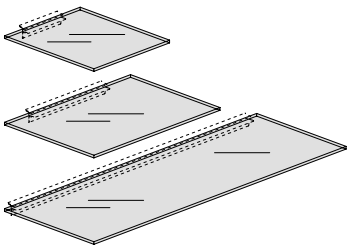
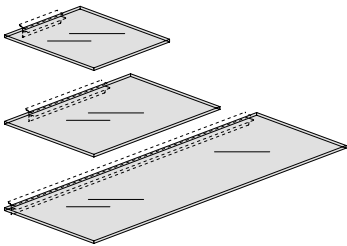
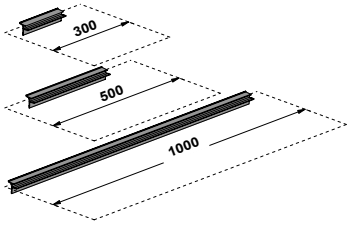

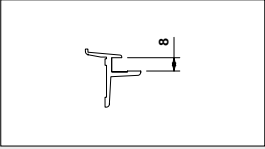
Details	P	H	L	Code	c1	c2	c3	c4	c5	c6
<b>Glass shelf holder</b>										
		8	150	<b>1B27 110</b>					◇	
		8	300	<b>1B27 111</b>					◇	
		8	940	<b>1B27 112</b>					◇	
<b>Laminated glass</b>										
<b>Maximum weight</b>		250	8	300	<b>1B23 020</b>					
L=300	4kg									
<b>Maximum weight</b>		250	8	500	<b>1B23 021</b>					
L=500	7kg									
<b>Maximum weight</b>		250	8	1000	<b>1B23 022</b>					
L=1000	14kg									
<b>Toughened glass</b>										
<b>Maximum weight</b>		250	8	300	<b>1B23 030</b>					
L=300	4kg									
<b>Maximum weight</b>		250	8	500	<b>1B23 031</b>					
L=500	7kg									
<b>Maximum weight</b>		250	8	1000	<b>1B23 032</b>					
L=1000	14kg									





# Metal Accessories

Program  
**Slatwall@Thinline**

Details

P	H	L	Code	c1	c2	c3	c4	c5	c6
---	---	---	------	----	----	----	----	----	----

**High load capacity shelf brackets**  
Suitable only for 60mm or 120mm ctc groove configuration

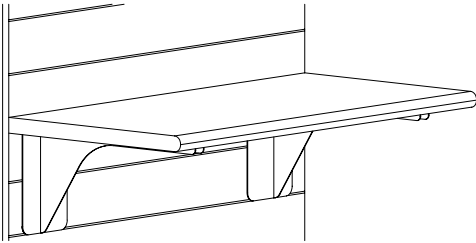

**350x 120mm brackets**  
(sold as a pair)

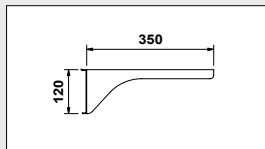
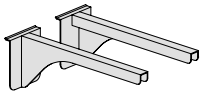

100	120	350	<b>1B28 114</b>	<b>CJ</b>					
-----	-----	-----	-----------------	-----------	--	--	--	--	--

Maximum weight
<b>40kg per shelf</b>

**450x 240mm brackets**  
(sold as a pair)

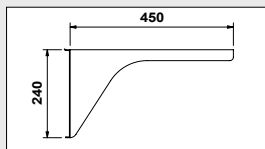
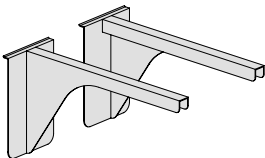



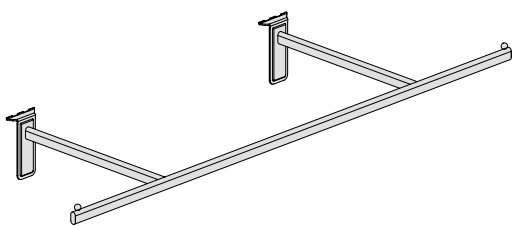
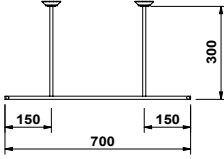
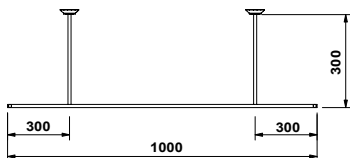
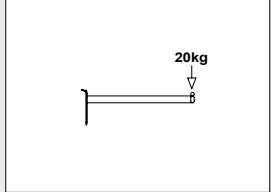
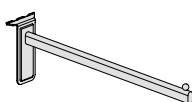
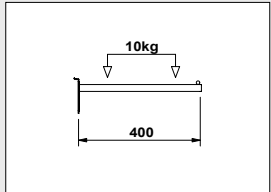
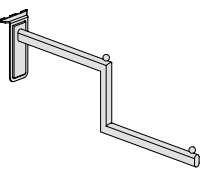
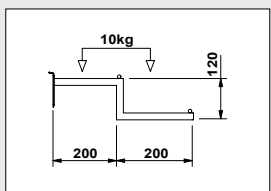

150	240	450	<b>1B28 115</b>	<b>CJ</b>					
-----	-----	-----	-----------------	-----------	--	--	--	--	--

Maximum weight
<b>70kg per shelf</b>

# Metal Accessories

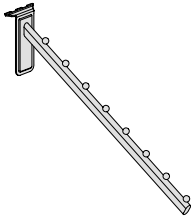
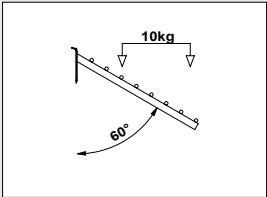
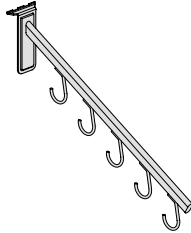
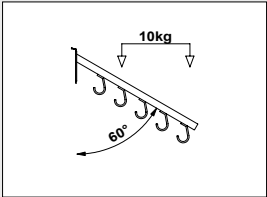
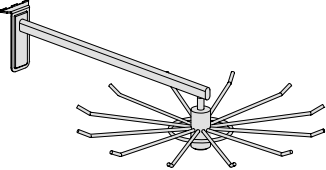
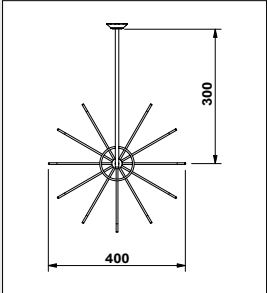
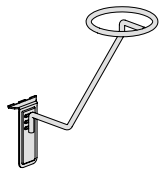
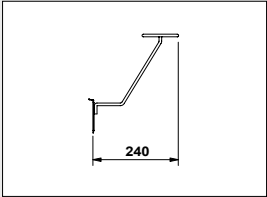
Program <b>Slatwall®Thinline</b>	Details	P	H	L	Code	c1	c2	c3	c4	c5	c6
<p><b>Hang rail</b></p>   											
					300 700 <b>1B28 101</b>						☒
					300 1000 <b>1B28 102</b>						☒
<p><b>Straight arm</b></p> 											
					400 <b>1B28 105</b>						☒
<p><b>Cranked arm</b></p> 											
					400 120 <b>1B28 106</b>						☒

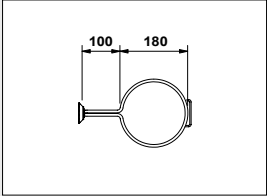
# Metal Accessories



Program <b>Slatwall®Thinline</b>		Details	P	H	L	Code	c1	c2	c3	c4	c5	c6
<b>Waterfall arms</b>		<b>Waterfall arm - 8 ball</b>										
		400				<b>1B28 107</b>						☒
		<b>Waterfall arm - 5 lower hooks</b>										
		400				<b>1B28 111</b>						☒
<b>Revolving display</b>												
		300	400			<b>1B28 108</b>						☒
<b>Hat holder</b>												
		240				<b>1B28 109</b>						☒
<b>Ball holder</b>												
		280	160			<b>1B28 110</b>						☒
												
	<b>Price holder</b>	40	70			<b>1B98 011</b>						▽

# Metal Accessories



Program <b>Slatwall®Thinline</b>		Details	P	H	L	Code	c1	c2	c3	c4	c5	c6
<b>Europrong</b> (4mm diameter)			180			<b>1B28 120</b>					☒	
<p>with price holder</p>			240			<b>1B28 121</b>					☒	
			300			<b>1B28 122</b>					☒	
		<b>Price holder</b>										
		<b>Security clip</b>										
		40	40			<b>1B98 010</b>					▼	
		40	70			<b>1B98 011</b>					▽	
<b>Display prong</b> (6mm diameter)			240			<b>1B28 130</b>					☒	
<p>with price holder</p>			300			<b>1B28 131</b>					☒	
			360			<b>1B28 132</b>					☒	
		<b>Price holder</b>										
		<b>Security clip</b>										
		40	70			<b>1B98 011</b>					▽	
<p>with price holder</p>		240				<b>1B28 135</b>					☒	
		300				<b>1B28 136</b>					☒	
		360				<b>1B28 137</b>					☒	
		<b>Price holder</b>										
		<b>Security clip</b>										
		40	70			<b>1B98 011</b>					▽	

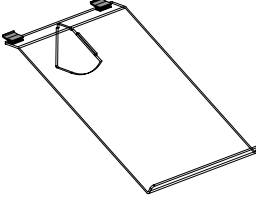
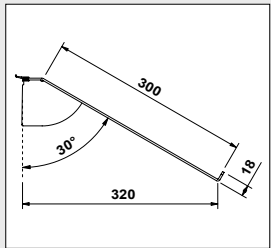
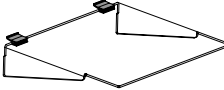
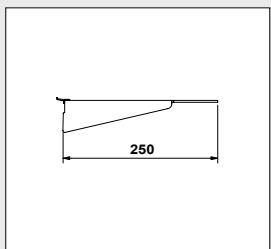
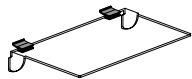
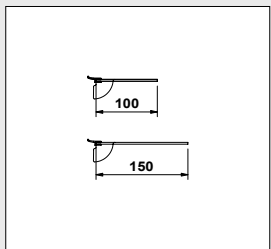
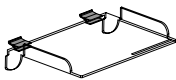
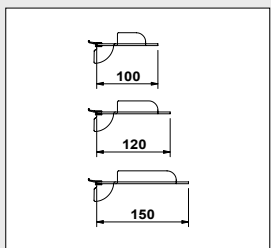
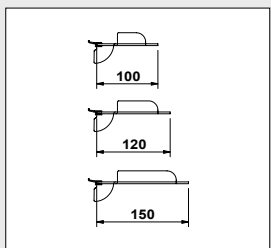

# Acrylic Accessories

Program <b>Slatwall®Thinline</b>	Details	P	H	L	Code	c1	c2	c3	c4	c5	c6
<p><b>Sloped display shelf</b></p> 		320	240		<b>1B28 050</b>					▽	
<p><b>Flat display shelf with supports</b></p> 		250	250		<b>1B28 063</b>					▽	
<p><b>Flat display shelf</b></p> 		100	250		<b>1B28 060</b>					▽	
<p><b>Flat display shelf with sides</b></p>   <p>with slot for price holder</p>		100	120		<b>1B28 065</b>					▽	
	<p><b>Price holder</b></p>	40	70		<b>1B98 011</b>					▽	

# Acrylic Accessories

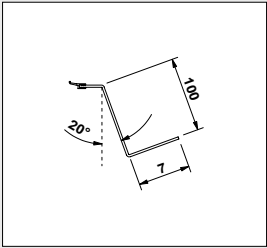
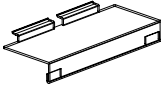
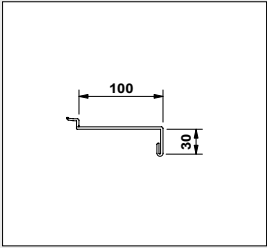
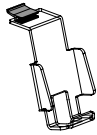
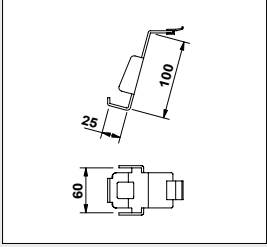
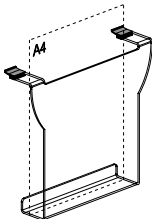
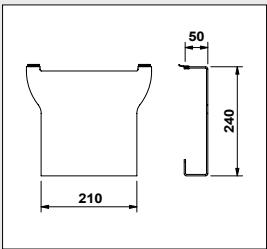
Program <b>Slatwall@Thinline</b>	Details	P	H	L	Code	c1	c2	c3	c4	c5	c6
<p><b>Sloped display shelf</b></p>  <p>with slot for price holder</p> 		70	100	120	<b>1B28 070</b>					▽	
<p><b>Flat display shelf with ticketing lip</b></p> 		100	40	250	<b>1B28 075</b>					▽	
<p><b>Mobile phone holder</b></p> 		90	100	60	<b>1B28 076</b>					▽	
<p><b>Magazine holder</b></p> 		50	240	210	<b>1B28 077</b>					▽	

