

smartrack

Smarrtrack profile featuring small and large coverplate combination and round Click-in straight arm with Slatwall backplate



smartrack

minimalist, seamless,
unobtrusive

Eyeline SmarTrack is the innovative yet simple solution for wall and freestanding merchandising display requirements.

Lengths of Eyeline SmarTrack are easy to install at any height, with no back-fixing required. The base extrusion is screw-fixed at the desired height and the curved radius profiles simply clip into place and conceal the screw fixings, leaving a streamlined, curved merchandising surface. Available in two sizes, both unobtrusive profiles provide uninterrupted vision of your display. The wide variety of display accessories available ensure you can accommodate any requirement from shelving to hang-rail displays. Simply choose the profile combination which best suits your merchandising needs.



SmarTrack profile featuring small cover plate combination and round Click - in accessories - Giftware, NSW



SmarTrack profile featuring small and large cover plate combination and ASI Metal accessories - Anita Holland Boutique, Cronulla NSW



SmarTrack wall display - featuring small and large cover plate combination and ASI Metal accessories - Anita Holland Boutique, Cronulla NSW

Features and Benefits

Aesthetic in design	<ul style="list-style-type: none">• Comprises just three basic components (base extrusion and choice of two coverplates)
Minimalist, seamless, unobtrusive	<ul style="list-style-type: none">• Contemporary design with uninterrupted sightlines• Fits together seamlessly to create a picture rail effect• Available in bar lengths up to 5 metres
Unlimited horizontal merchandising flexibility	<ul style="list-style-type: none">• Suitable for walls, floor fixtures and exhibition and display stands
Vast range of accessories	<ul style="list-style-type: none">• Smaller radius profile utilises specially designed SmarTrack accessories• Larger radius accepts standard Slatwall hardware
Made from aluminium	<ul style="list-style-type: none">• Lightweight• Zero fire-rated and recyclable

Finishes Available in Matt Natural anodised finish. Powdercoating and other anodised finishes available on request.

Applications Offering unlimited horizontal merchandising flexibility, SmarTrack is suitable for walls, floor fixtures and exhibition and display stands. It can even be coloured to achieve the effect of merchandise being suspended in thin air.

SmarTrack Range

SmarTrack – Base Extrusion 5000mm
EST02MN (Matt Natural)

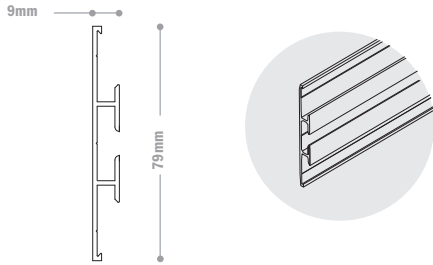

Large Plastic End Cap (for use with large coverplates)

EST01CAPCL (Clear)

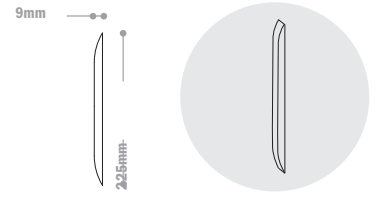

Medium Plastic End Cap – Left & Right (for use with combination of small and large coverplates)

EST02CAPCLLH (Clear)

EST02CAPCLRH (Clear)

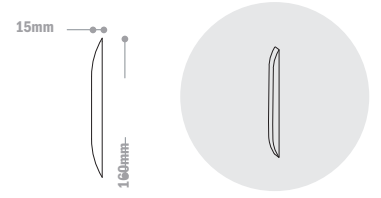

SmarTrack – Small Radius Coverplate 5000mm
EST03MN (Matt Natural)



Small Plastic End Cap (for use with small coverplates)

EST03CAPCL (Clear)



Combinations

Simply choose the Smartrack profile combination which best suits your requirements

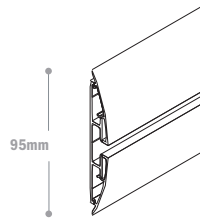

Join two small profiles

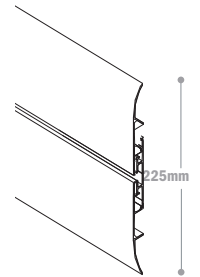

Join two large profiles

SmarTrack – Large Radius Coverplate 5000mm
EST01MN (Matt Natural)

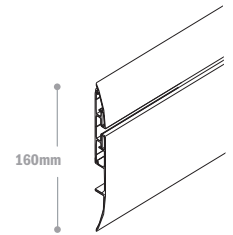
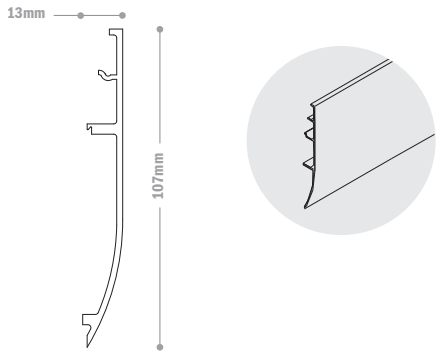

Combine one of each (Small & Large)

Please refer to the ASI accessories brochure to view range of versatile display accessories.



| National Dealer Network 1300 SLATWALL(752 892) | www.asionline.com.au | contact@asionline.com.au |

Distributed by: